

Metal bodied limit switch

Series SN2

Description **SN2-U1Z RIW**

Article number **6033117025**

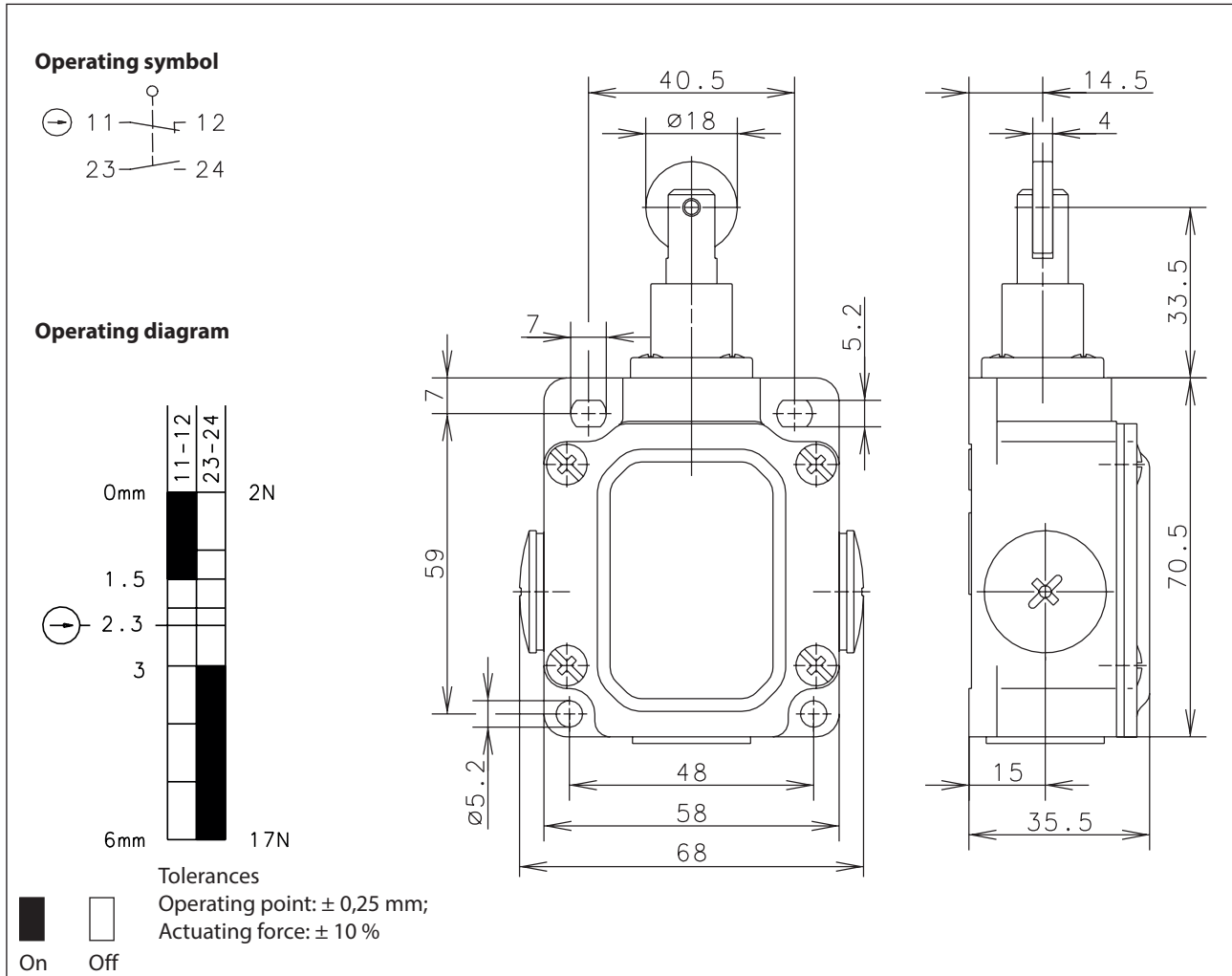

Electrical Data		
Rated insulation voltage	U_i	400 V AC
Conv. thermal current	I_{the}	10 A
Rated operational voltage	U_e	240 V
Utilization category		AC-15, U_e/I_e 240 V / 3 A
Direct opening action	\ominus	acc. to IEC/EN 60947-5-1, annex K
Short-circuit protective device		Fuse 10 A gG
Protection class		I

Mechanical data	
Enclosure	Die-cast aluminium
Cover	Sheet aluminium
Actuator	Roller (st)
Ambient air temperature	-30 °C ... +80 °C
Contact type	1 NC, 1 NO (Zb)
Mechanical life	10 x 10 ⁶ operating cycles
Switching frequency	≤ 100 / min.
Assembly	4 x M5
Connection	4 screw connections (M3,5)
Conductor cross-sections	Solid: 0,5 ... 1,5 mm ² or Litz wire with ferrules: 0,5 ... 1,5 mm ²
Cable entrance	3 x M20 x 1,5
Weight	≈ 0,2 kg
Installation position	operator definable
Protection type	IP65 acc. to IEC/EN 60529

Actuation
By loosening the 4 screws the actuation assembly can be rotated in 90 degree increments such that 2 actuation directions are possible. The actuation assembly is to be again fastened to the housing using the 4 screws.

Standards
VDE 0660 T100, DIN EN 60947-1, IEC 60947-1
VDE 0660 T200, DIN EN 60947-5-1, IEC 60947-5-1

EU Conformity
acc. to directive 2014/35/EU

Approvals
cCSA _{US}

Notes
The degree of protection specified (IP65) applies only to a properly closed cover and the use of an equivalent cable gland with adequate cable and fitted inserts. Unused threaded holes are to be permanently closed with appropriate fitted inserts (e.g.: blanking plugs).